

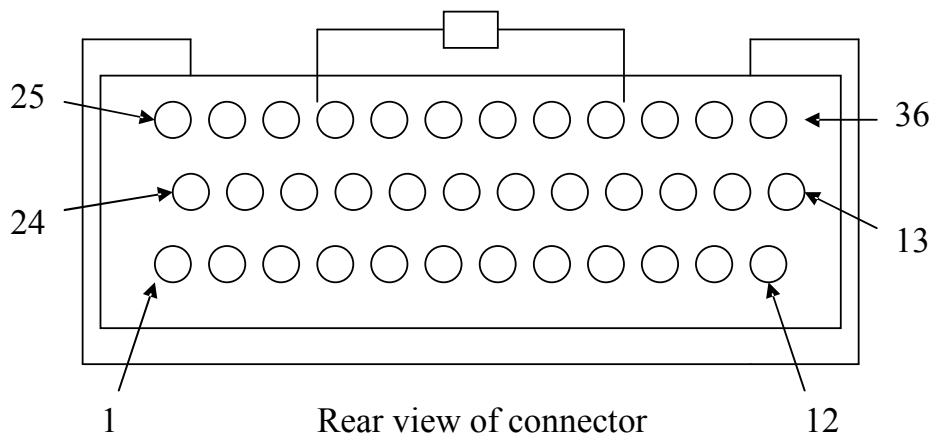



















# K6 part loom wiring details

















36-way ECU connector

Inductive Crank Sensor



## Part loom – ECU pin out table with wire colour convention

ECU pin	Wire colour	Connection	Comments
1	 Yellow/black, 0.5mm <sup>2</sup>	Injector driver 4	Injector driver or AuxOut1
2	 Orange/Blue, 0.5mm <sup>2</sup>	IACV2	IACV driver or AuxOut2
3	 Orange/Green, 0.5mm <sup>2</sup>	IACV1	IACV driver or AuxOut3
4	 Green/Yellow, 0.5mm <sup>2</sup>	Ignition driver 3	Ignition driver or main relay driver Note: If not configured as an ignition driver this output will default to a main relay driver
5	 Green/Black, 0.5mm <sup>2</sup>	Ignition driver 2	Ignition driver or AuxOut5
6	 Blue/Yellow, 0.5mm <sup>2</sup>	Cooling fan relay control	
7	 White/Pink, 0.5mm <sup>2</sup>	AuxIn7	O2 sensor 1 signal input
8	 Green, 0.5mm <sup>2</sup>	Throttle pot signal input	0-5v input
9	 Red, 0.5mm <sup>2</sup>	+5v out	5v output, 100mA max
10	 White/Yellow, 0.5mm <sup>2</sup>	AuxIn10	0-5v input. This input has an internal pull-up resistor (1KΩ to +5v) that can be enabled via ECU configuration settings
11	 Red/Black, 0.5mm <sup>2</sup>	Ignition sense input	+12v supply via ignition switch
12	 Yellow, 0.5mm <sup>2</sup>	Tacho output signal	12v pulsed output (open collector driver with internal 2.2KΩ pull-up to +12v)
13	 White/Green, 0.5mm <sup>2</sup>	Immobilisor input	Aux digital input
14	 Blue/Red, 0.5mm <sup>2</sup>	AuxIn14 / AuxOut14	
15	 White, 0.5mm <sup>2</sup>	Cam sync/Custom input	
16	 White, 0.5mm <sup>2</sup>	Air temp signal	
17	 Yellow/Pink, 0.5mm <sup>2</sup>	Injector driver 5	Injector driver or AuxOut17
18	 White/Black, 0.5mm <sup>2</sup>	Oxygen sensor signal earth	
19	 Blue/White, 0.5mm <sup>2</sup>	Ignition driver 4 / Shift-light driver	The function of this output depends on the ECU configuration settings

20		Brown, 0.5mm <sup>2</sup>	Fuel pump relay driver	Switches to ground when activated
21		Yellow/Orange, 0.5mm <sup>2</sup>	Injector driver 6	Injector driver or AuxOut21
22		Orange/Pink, 0.5mm <sup>2</sup>	IACV3	IACV driver or AuxOut22
23		Yellow/Red, 0.5mm <sup>2</sup>	Injector driver 2	Injector driver only
24		Yellow/Brown, 0.5mm <sup>2</sup>	Injector driver 1	Injector driver only
25		Green/White, 0.5mm <sup>2</sup>	Ignition driver 1	Ignition driver only
26		Yellow/White, 0.5mm <sup>2</sup>	Injector driver 3	Injector driver or AuxOut26
27		Orange/Slate, 0.5mm <sup>2</sup>	IACV4	IACV driver or AuxOut27
28		Red, 0.5mm <sup>2</sup>	+12v Ignition supply	Supply from main relay or common with pin 11
29		Black, 1.0mm <sup>2</sup>	ECU ground	Good ground (e.g. direct to battery)
30		Black, 0.5mm <sup>2</sup>	Sensor ground	Ground return for sensors. Note: This must not be connected to battery or chassis ground – only to ECU related sensors.
31		Red, 0.5mm <sup>2</sup>	Main trigger signal input	Crank sensor signal
32		Black, 0.5mm <sup>2</sup>	Main trigger sensor ground	Signal ground for Crank/Cam sensors
33		Blue, 0.5mm <sup>2</sup>	Coolant temp signal input	
34		Purple, 0.5mm <sup>2</sup>	AuxIn34	0-5v input, commonly used for reading the MAP sensor signal
35		White/Red, 0.5mm <sup>2</sup>	AuxIn35	0-5v input. This input has an internal pull-up resistor (1KΩ to +5v) that can be enabled via ECU configuration settings
36		Blue/Black, 0.5mm <sup>2</sup>	AuxIn36 / AuxOut36	0-5v input or switched ground output depending on ECU configuration settings.

Note:

Ignition outputs are green+tracer wires  
 Injector outputs are yellow+tracer wires  
 IACV outputs are orange+tracer wires  
 Aux inputs are white+tracer wires  
 Aux outputs are blue+tracer wires

The part loom is supplied with the following cables already fitted to the 36-way connector

- Supply
  - Red/black, ECU pin 11, +12v from ignition switch.
  - Red, ECU pin 28, +12v from main relay.
  - Thick black, ECU pin 29, ground to battery.

Note: For most applications the red/black and red power wires can be joined and wired to an ignition controlled +12v supply. For applications that require ECU controlled shutdown, e.g. stepper motor resync' and/or cooling fan control after key-off, wire the red/black cable to ignition switched supply and the red cable to the ECU controlled main relay.

- Main trigger cable (shielded cable)
  - Inductive crank/distributor sensor
    - Red, sensor signal +, ECU pin 31.
    - Black, sensor signal ground, ECU pin 32.
    - Shield, Crank trigger shield (joined with wire at ECU pin 30)
- Air temperature sensor (white/black twisted pair cable)
  - White, ECU pin 16, air temperature sensor signal.
  - Black, ECU pin 30, sensor ground.
- Coolant temperature sensor (blue/black twisted pair cable)
  - Blue, ECU pin 33, coolant temperature sensor signal.
  - Black, ECU pin 30, sensor ground.
- Throttle Position Sensor (red/green/black twisted cable)
  - Red, +5v sensor supply, ECU pin 9.
  - Green, sensor signal, ECU pin 8.
  - Black, sensor ground, ECU pin 30.
- MAP sensor (red/purple/black twisted cable)
  - Red, +5v sensor supply, ECU pin 9.
  - Purple, sensor signal, ECU pin 34.
  - Black, sensor ground, ECU pin 30.
- Tacho signal
  - Yellow, tacho signal, ECU pin 12.
- Fuel pump control
  - Brown, switched ground fuel pump control, ECU pin 20.
- Shift light
  - Blue/white, switched ground lamp control, ECU pin 19.

Cables for other ECU functions are included. Select the cable colour according to the colour codes shown in the pin-out table.

### Example 1.

A 4-cylinder engine with a firing order of 1-3-4-2. Use the part loom supplied with the following additional cables...

- Ignition coil
  - Single coil with distributor  
Coil negative terminal, green/white cable to ECU pin 25.
  - Distributorless (wasted spark) ignition  
Coil 1 for cylinders 1&4, green/white cable to ECU pin 25.  
Coil 2 for cylinders 2&3, green/black cable to ECU pin 5.
- Injectors
  - Injectors wired in pairs using 2 injector drivers  
Injectors 1&4, yellow/brown cable to ECU pin 24.  
Injectors 2&3, yellow/red cable to ECU pin 23.
  - Injectors wired individually to 4 injector drivers  
Injector 1, yellow/brown cable to ECU pin 24.  
Injector 3, yellow/red cable to ECU pin 23.  
Injector 4, yellow/white cable to ECU pin 26.  
Injector 2, yellow/black cable to ECU pin 1

### Example 2.

A 6-cylinder engine with a firing order of 1-5-3-6-2-4. Use the part loom with the following additional cables...

- Ignition coil
  - Single coil with distributor  
Coil negative terminal, green/white cable to ECU pin 25.
  - Distributorless (wasted spark) ignition  
Coil 1 for cylinders 1&6, green/white cable to ECU pin 25.  
Coil 2 for cylinders 2&5, green/black cable to ECU pin 5.  
Coil 3 for cylinders 3&4, green/yellow cable to ECU pin 4.
- Injectors
  - Injectors wired in pairs using 3 injector drivers  
Injectors 1&6, yellow/brown cable to ECU pin 24.  
Injectors 2&5, yellow/red cable to ECU pin 23.  
Injectors 3&4, yellow/white cable to ECU pin 26.
  - Injectors wired individually to 6 injector drivers  
Injector 1, yellow/brown cable to ECU pin 24.  
Injector 5, yellow/red cable to ECU pin 23.  
Injector 3, yellow/white cable to ECU pin 26.  
Injector 6, yellow/black cable to ECU pin 1.  
Injector 2, yellow/pink cable to ECU pin 17.  
Injector 4, yellow/orange cable to ECU pin 21.

### Example 3.

An 8-cylinder engine with a firing order of 1-8-4-3-6-5-7-2. Use the part loom with the following additional cables...

- Ignition coil
  - Single coil with distributor
    - Coil negative terminal, green/white cable to ECU pin 25.
  - Distributorless (wasted spark) ignition (ECU hardware v1.40 only)
    - Coil 1 for cylinders 1&6, green/white cable to ECU pin 25.
    - Coil 2 for cylinders 5&8, green/black cable to ECU pin 5.
    - Coil 3 for cylinders 4&7, green/yellow cable to ECU pin 4.
    - Coil 4 for cylinders 2&3, blue/white cable to ECU pin 19.
  - Injectors wired in pairs to 4 injector drivers
    - Injectors 1&6, yellow/brown cable to ECU pin 24.
    - Injectors 5&8, yellow/red cable to ECU pin 23.
    - Injectors 4&7, yellow/white cable to ECU pin 26.
    - Injectors 2&3, yellow/black cable to ECU pin 1.

### Caution:

The ECUs ignition coil drivers have secondary uses.

Ensure the ECU is correctly configured to suit your ignition system before the ignition coils are connected.